

Rozmery v mm
 Maße in mm
 Dimensions in mm

Heat 2g 70.44.01

168 kg

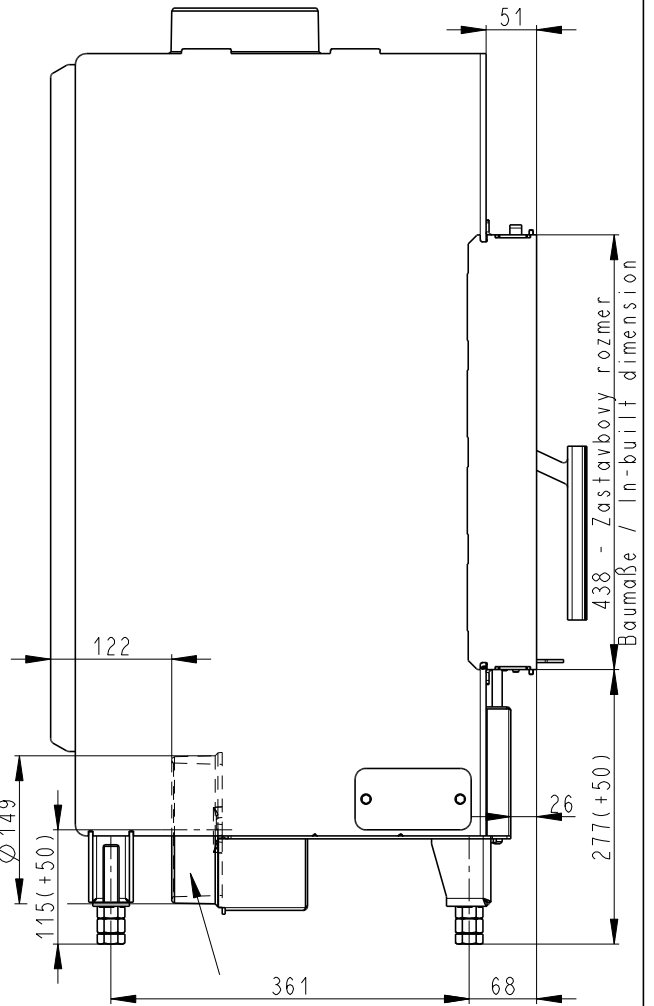
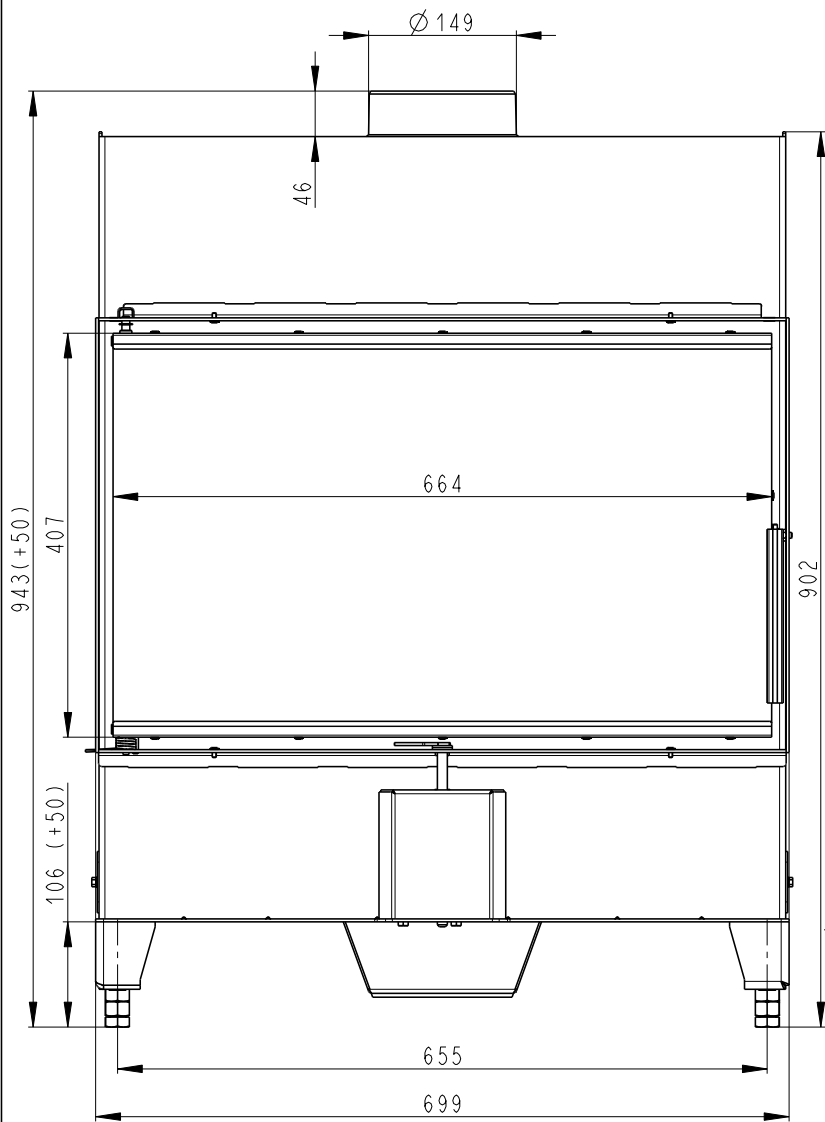

Centralni privod vzduchu
 Central air inlet
 Zentralluftzufuhr

Litinový odvod kouře
 Cast iron spigot
 Der gusseiserne Rauchabgang

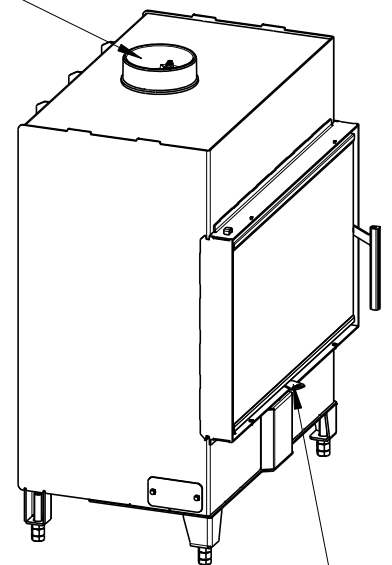
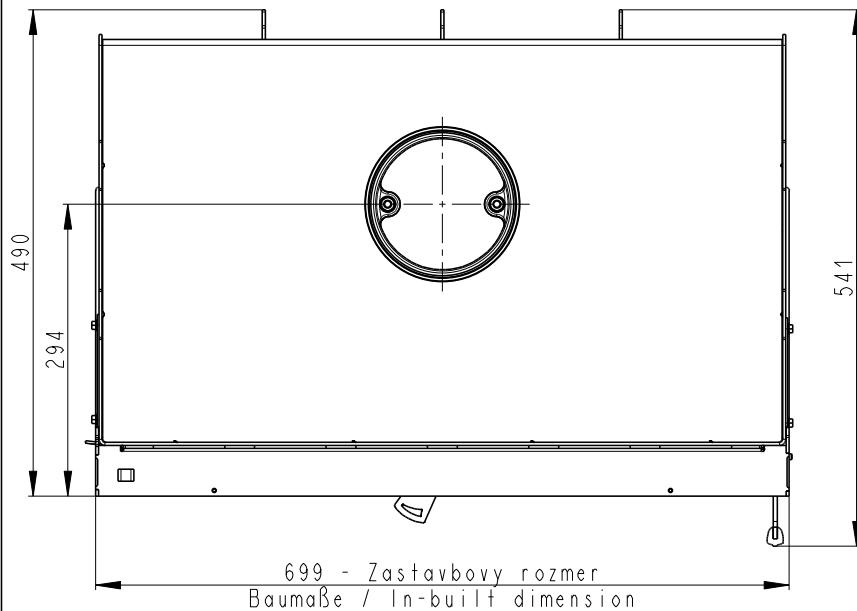

Primarni a sekundarni vzduch
 Primärluft und Sekundärluft
 Primary and secondary air